

# Nordic Cabinet Ordering Key

## for Elastimold Multi-Point Junctions

### ND-325-MG-UNI4-325B2V2-W3B

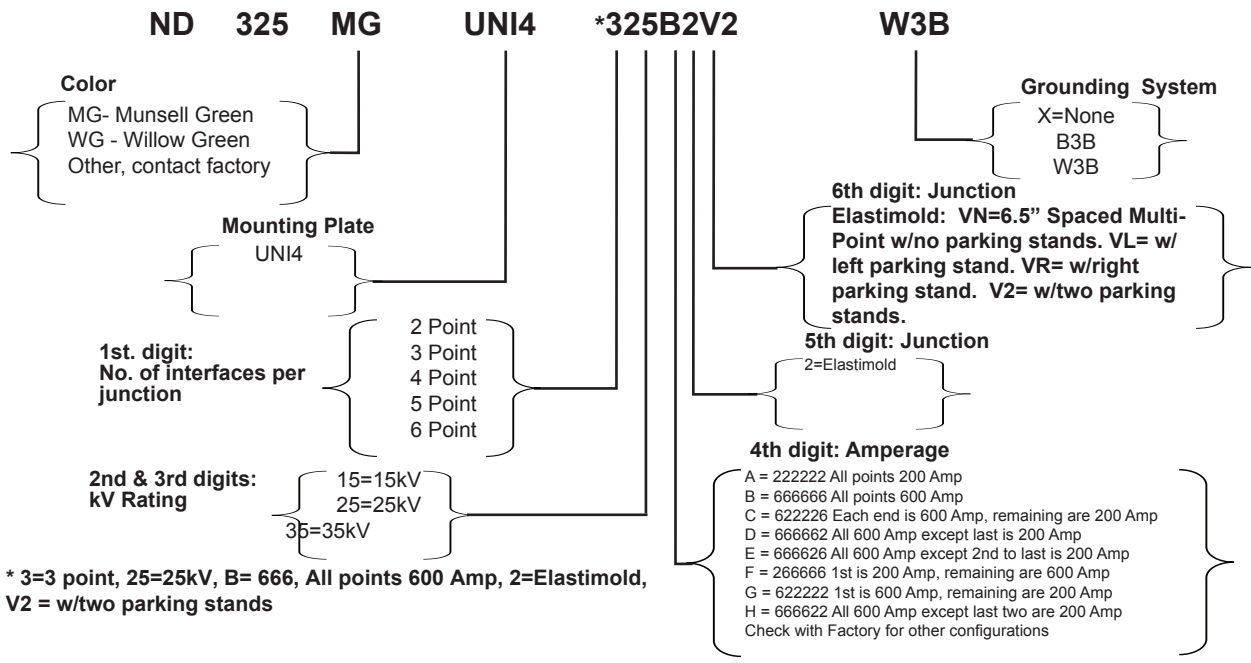

Page 1 of 3  
 for 4" interface spacing, see page 2.  
 for 6.5" interface spacing, see page 3.

### Elastimold Molded Multi-Point Junctions with 4" Interface Spacing

#### No Parking Stands

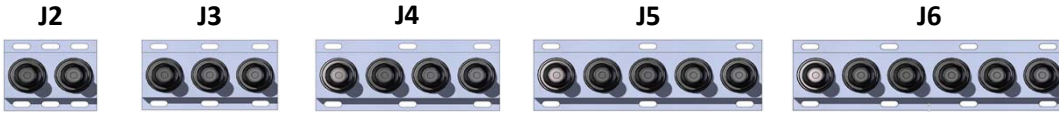

Elastimold 4" Interface Multi-Point Junction (no parking stands)	J2	J3	J4	J5	J6
Junction Width	8"	12"	16"	20"	24"
ND-325-MG-X-X-X, ND-325-MG-PS14A-X-X, ND-325-MG-UNI4 Cabinets Accommodate:	Yes	Yes	Yes	Yes	Yes

#### One Parking Stand

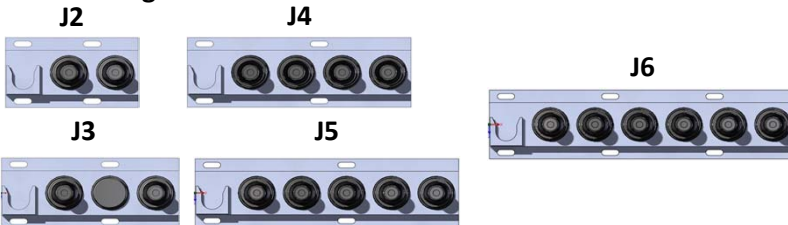

Elastimold 4" Interface Multi-Point Junction (one parking stand located either left or right side)	J2	J3	J4	J5	J6
Junction Width	11.5"	15.5"	19.5"	23.5"	27.5"
ND-325-MG-X-X-X, ND-325-MG-PS14A-X-X, ND-325-MG-UNI4 Cabinets Accommodate:	Yes	Yes	Yes	Yes	Yes

#### Two Parking Stands

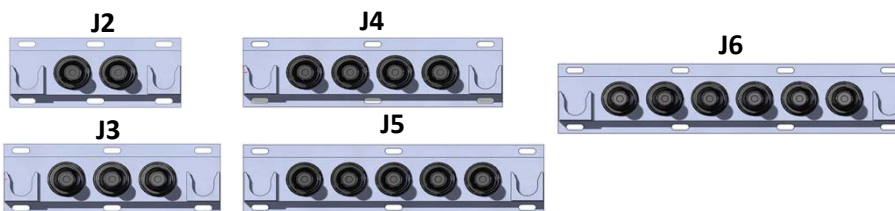

Elastimold 4" Interface Multi-Point Junction (two parking stands)	J2	J3	J4	J5	J6
Junction Width	15"	19"	23"	27"	31"
ND-325-MG-X-X-X, ND-325-MG-PS14A-X-X, ND-325-MG-UNI4 Cabinets Accommodate:	Yes	Yes	Yes	Yes	No

### Elastimold Molded Multi-Point Junctions with 6.5" Interface Spacing

#### No Parking Stands

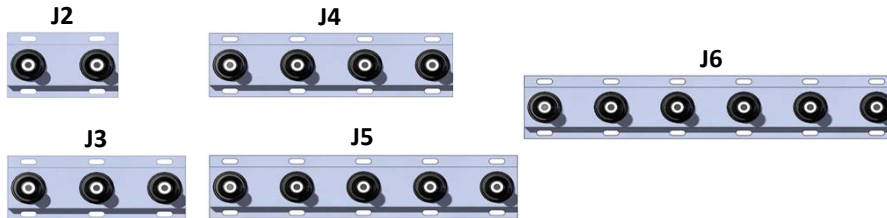

V=6.5" Spaced Multi-Point w/No Parking Stands					
Type of Junction	J2	J3	J4	J5	J6
Junction Width	10.5"	17"	23.5"	30"	36.5"
ND-325-MG-X-X-X, ND-325-MG-PS14A-X-X , ND-325-MG-UNI4 Cabinets Accommodate:	Yes	Yes	Yes	No	No

#### One Parking Stand

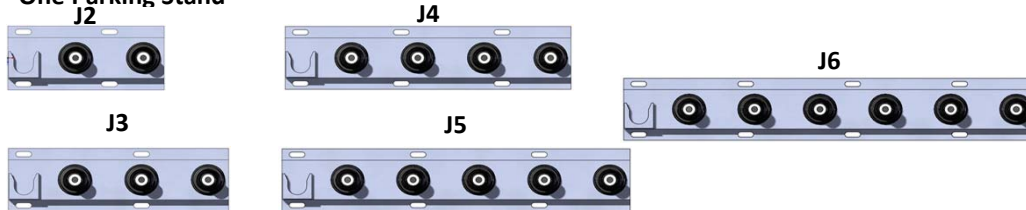

V1=with one parking stand (parking stands can be located either left or right side)					
Type of Junction	J2	J3	J4	J5	J6
Junction Width	15"	21.5"	28"	34.5"	41"
ND-325-MG-X-X-X, ND-325-MG-PS14A-X-X , ND-325-MG-UNI4 Cabinets Accommodate:	Yes	Yes	Yes	No	No

#### Two Parking Stands

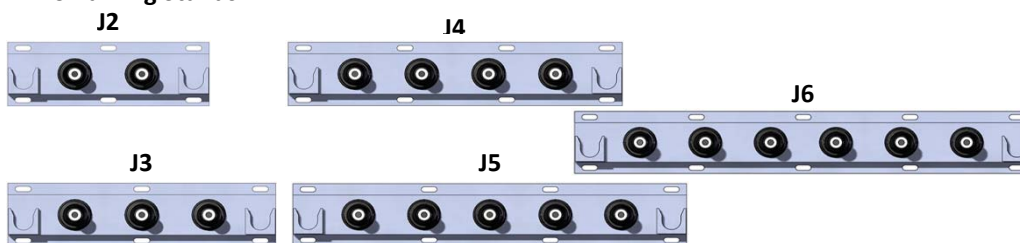

V2=w/two parking stands					
Type of Junction	J2	J3	J4	J5	J6
Junction Width	19.5"	26"	32.5"	39"	45.5"
ND-325-MG-X-X-X, ND-325-MG-PS14A-X-X , ND-325-MG-UNI4 Cabinets Accommodate:	Yes	Yes	No	No	No