

REVISIONS			
REV.	DESCRIPTION	DATE	APPROVED
REL-01		5/30/2007	

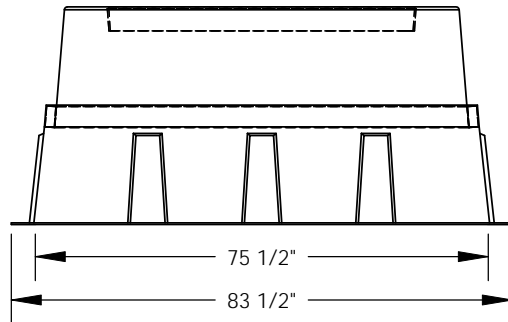
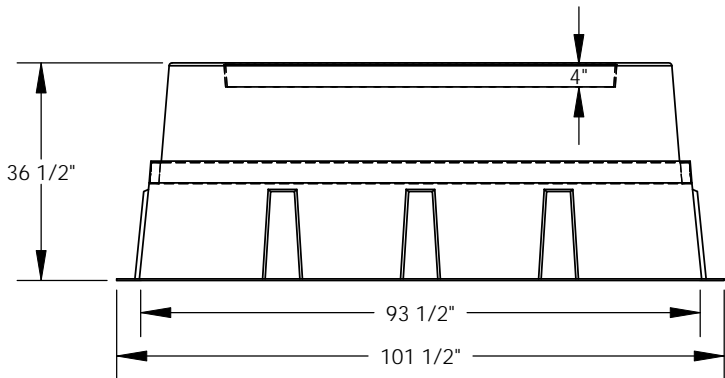
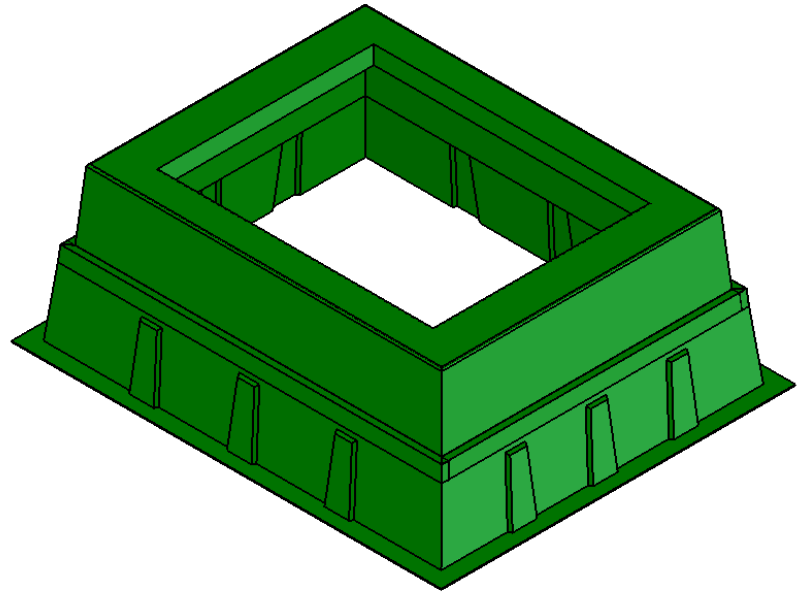
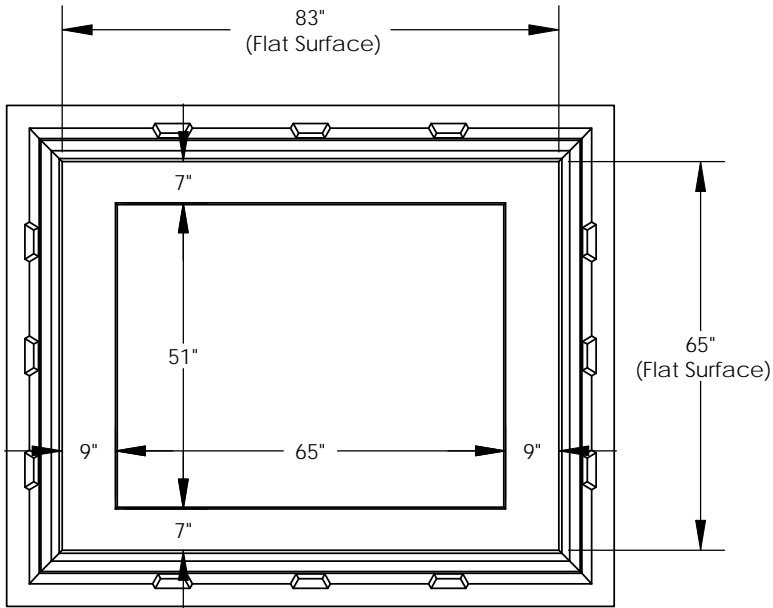

**PROPRIETARY AND CONFIDENTIAL**  
 THE INFORMATION CONTAINED IN THIS DRAWING IS THE SOLE PROPERTY OF NORDIC FIBERGLASS, INC. ANY REPRODUCTION IN PART OR AS A WHOLE WITHOUT THE WRITTEN PERMISSION OF NORDIC FIBERGLASS, INC. IS PROHIBITED.

Customer Name: N/A		
DIMENSIONS ARE IN INCHES		
TOLERANCES: ANGLES $\pm 1^\circ$		
FRACTIONAL $\pm 1/2$		
ONE PLACE DECIMAL $\pm .060$		
TWO PLACE DECIMAL $\pm .030$		
THREE PLACE DECIMAL $\pm .015$		
MATERIAL		
DRAWN	NAME	DATE
	P.J.W.	05/30/07
CHECKED	---	--/--/--

**Nordic Fiberglass, Inc.**  
 21415 US Hwy 75 NW, Warren, MN 56762  
 www.nordicfiberglass.com  
 218-745-5095 ph. --- 218-745-4990 fax

GS-84-66-36-MG-65x51

SIZE	ITEM ID:	REV.
<b>A</b>	01950.00	<b>REL-01</b>
SCALE:1:32		SHEET 1 OF 1